

Photron



Compact high-speed camera with high image resolution

The FASTCAM Mini WX100 high-speed camera delivers exceptional high resolution imaging performance by providing 2048 x 2048 pixel resolution at 1,080fps (Mini WX50 750fps), 1920 x 1080 pixel full HD resolution at 2,000fps (Mini WX50 1,500fps) and frame rates up to 80,000fps (Mini WX50 67,500fps) at reduced image resolution. The system's flexible Region of Interest (ROI) capability allows the user to choose an image aspect ratio appropriate for the subject being recorded.

The FASTCAM Mini WX is compact, lightweight and also rugged (operationally tested to 100G, 10ms, 6-axes). This unique combination of high resolution imaging performance in a compact, lightweight and rugged package makes the system well suited to a wide range of industrial and scientific applications. It is ideally suited for biomechanics, microscopy, automotive safety testing and defense applications.

The FASTCAM Mini WX utilizes Photron's proprietary CMOS image sensor design expertise, including on-chip microlens technology to optimize light sensitivity. The camera provides broadcast quality high definition image resolution, color fidelity and dynamic range. Recording memory options from 8GB to 32GB permit the capture of over 10 seconds of uncompressed and un-interpolated data at 1,000fps with full HD image resolution.

Standard operational features of the FASTCAM Mini WX include a mechanical shutter to allow remote system calibration, Gigabit Ethernet Interface for reliable system control with high-speed data transfer to PC, and the ability to switch off cooling fans to eliminate vibration when recording at high magnifications.

FASTCAM Mini WX

Model WX50 / WX100

4-Megapixel CMOS Sensor:

Mini WX50

2048 x 2048 pixels at 750fps

1920 x 1080 pixels at 1,500fps

Mini WX100

2048 x 2048 pixels at 1,080fps

1920 x 1080 pixels at 2,000fps

Maximum Frame Rate:

67,500fps (Mini WX50 type 67.5K)

80,000fps (Mini WX100 type 80K)

Class Leading Light Sensitivity:

ISO 12232 Ssat

- ISO 6,400 monochrome

- ISO 2,000 color

Global Electronic Shutter:

1ms to 2.7 μ s independent of frame rate

Dynamic Range (ADC):

12-bit monochrome, 36-bit color

Compact and Lightweight:

120mm (H) x 120mm (W) x 99mm (D)

4.72" (H) x 4.72" (W) x 3.90" (D)

Weight: 1.6Kg (3.52 lbs.)

Internal Recording Memory:

8GB, 16GB, or 32GB

Fast Gigabit Ethernet Interface:

Provides high-speed image download to standard notebook/PC

Flexible Frame Synchronization:

Frame rate may be synchronized to external unstable frequencies

High-G Rated:

Suitable for application in high-G environments;

Operation tested to 100G, 10ms, 6-axes

Fan Stop Function:

Remotely switch off cooling fans to eliminate vibration



Photo: Automotive side impact test, 1,000fps

Light Sensitivity:

Expressions of light sensitivity in high-speed cameras can be confusing as a variety of differing measurement techniques are used. Photron publishes light sensitivity figures for its products using the ISO 12232 Ssat Standard.

| FASTCAM MINI WX | ISO 12232 Ssat |
|-------------------|----------------|
| Monochrome models | ISO 6,400 |
| Color models | ISO 2,000 |

ISO 12232 Ssat values published by Photron for both monochrome and color cameras are measured excluding infrared sensitivity as defined by the ISO standard measurement procedure ISO 14524.

Monochrome sensors used in the FASTCAM Mini WX cameras are supplied without an IR absorbing filter, extending the camera spectral response beyond 900nm. When the sensitivity of the FASTCAM Mini WX camera is measured to tungsten light including near IR response an equivalent value of ISO 16,000 is obtained.

Image Sensor:

The FASTCAM Mini WX system uses an advanced CMOS image sensor optimized for light sensitivity and high image quality that is unique to Photron.

A 10-micron pixel pitch gives a sensor size at full image resolution of 20.48 x 20.48mm (diagonal 28.96mm).

Lenses designed for both FX (35mm full frame) and also DX (APS-C digital SLR) formats are fully compatible with the FASTCAM Mini WX at full image resolution.

| | |
|-----------------------------|---|
| Sensor Type | Proprietary Design Advanced CMOS |
| Maximum Resolution (pixels) | 2048 x 2048 pixels |
| Sensor Size / Diagonal | 20.48 x 20.48mm / 28.96mm |
| Pixel Size (microns) | 10µm x 10µm |
| Quantum Efficiency | 43.8% at 630nm |
| Fill Factor | 42% |
| Color Matrix | Bayer CFA (single sensor) |
| ISO 12232 Ssat sensitivity | ISO 6,400 monochrome ISO 2,000 color (monochrome sensor equivalent ISO 16,000 including near IR response) |
| Shutter | Global Electronic Shutter 1ms to 2.7µs independent of frame rate |

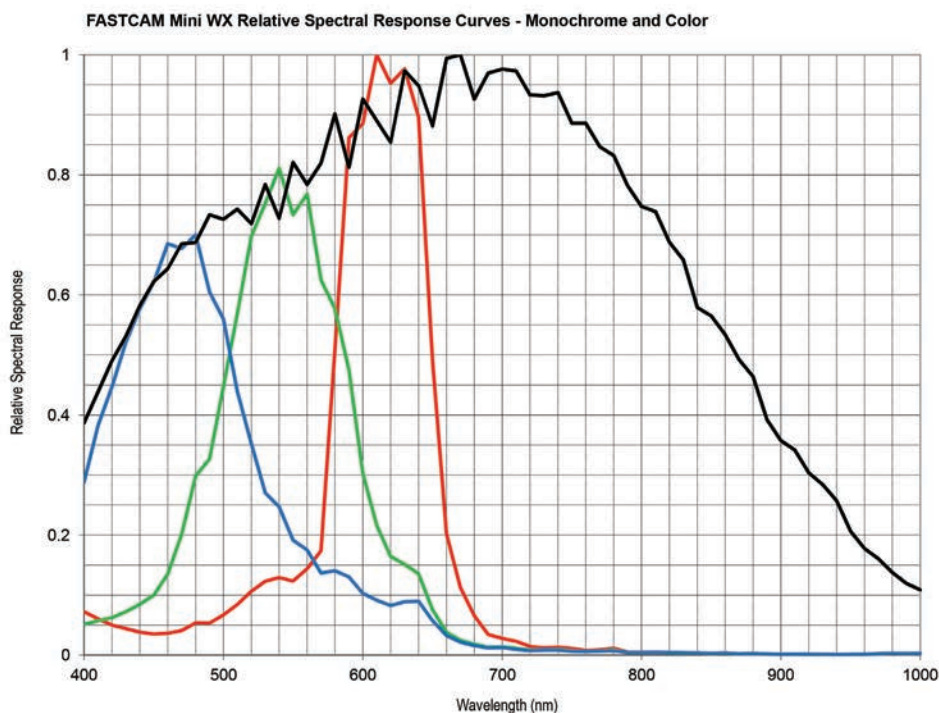

Camera Performance Specifications

| Model | Mini WX50 | Mini WX100 |
|---|--|---------------------------------------|
| Full Frame Performance | 750fps 2048 x 2048 pixels | 1,080fps 2048 x 2048 pixels |
| Maximum Frame Rate | Type 67.5K: 67,500fps (256 x 32 pixels) | Type 80K: 80,000fps (256 x 32 pixels) |
| Minimum Exposure | Global electronic shutter minimum exposure time independent of frame rate 2.7 μ s | |
| Inter-Frame Time (for PIV) | 2.6 μ s | |
| Ruggedized Mechanical Calibration Shutter | Standard feature | |
| Dynamic Range (ADC) | 12-bit monochrome 36-bit color | |
| Memory Capacity Options | 8GB: 1,361 frames at full resolution 16GB: 2,726 frames at full resolution 32GB: 5,457 frames at full resolution | |
| Memory Partitions | Up to 64 memory segments | |
| Region of Interest | Selectable in steps of 256 pixels (horizontal) x 32 pixels (vertical) | |
| Trigger Inputs | Selectable +/- TTL and switch closure FET input 0V +/-12V (H level +2.5V to +12V) | |
| Trigger Delay | Programmable on selected input / output triggers: 100ns resolution | |
| Input / Output | Input: Trigger (TTL/Switch), sync, ready, event, IRIG Output: trigger, sync, ready, rec, exposure | |
| Trigger Modes | Start, end, center, manual, random, random reset, image trigger, time lapse | |
| Time Code Input | IRIG-B | |
| External Sync | +/- TTL Variable frequency sync FET input 0V +/-12V (H level +2.5V to +12V) | |
| Camera Control Interface | High-speed Gigabit Ethernet | |
| Image Data Display | Memory status, Frame rate, shutter speed, trigger mode, date/time, status, real time / IRIG time, frame count, resolution, LUT and comment | |
| Saved Image Formats | BMP, TIFF, JPEG, PNG, RAW, RAWW, MRAW, AVI, WMV, FTIF, MOV - Images can be saved with or without image data and in 8-bit, 16-bit or 36 bit depth of sensor where supported | |
| Supported OS | Microsoft Windows operating system including: XP, Vista, 7, 8, 8.1, 10 (32/64-bit) | |

High-Speed Gigabit Ethernet Interface:

The FASTCAM Mini WX camera system is equipped with a high-speed Gigabit Ethernet Interface to provide reliable network communication and fast download of image data.

Dedicated I/O:

A dedicated BNC connection for a contact closure hardware trigger input is provided. In addition, two programmable inputs and two programmable output channels provide direct connection for common tasks such as synchronization of multiple cameras and operation in conjunction with Data Acquisition (DAQ) hardware.

High-G Mechanical Calibration Shutter:

The ruggedized mechanical shutter fitted as standard to the FASTCAM Mini WX camera allows sensor black balance calibration to be carried out remotely from the system control software.

Nikon G-Type Compatible Lens Fitting:

The FASTCAM Mini WX camera is equipped with an objective lens mount compatible with readily available Nikon G-type lenses. Controls provided within the lens mount allow the control of lens aperture on lenses without external iris control.

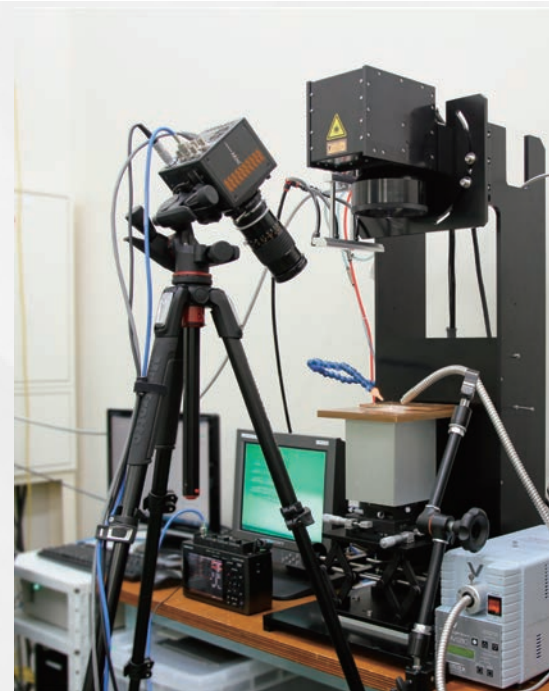

Camera Operation Features

| | |
|--|--|
| Frame Synchronization | Accurate frame synchronization with other cameras and with external and unstable frequencies. |
| Dual Slope Shutter (Extended Dynamic Range) | Selectable in 20 steps (0 to 95% in 5% increments) to prevent pixel overexposure without post processing. |
| Memory Partitions | Up to 64 memory segments allow multiple events to be stored in camera memory before downloading, with automatic progression to the next available partition. |
| Low Light Mode | Operation at minimum frame rate with separately adjustable shutter time to allow easy camera set-up and focus in ambient lighting. |
| IRIG Phase Lock | Enables multiple cameras to be synchronized together with other instrumentation equipment or to a master external time source. |
| Internal Time Delay Generator | Allows programmable delays to be set on input and output triggers; 100ns resolution. |
| Event Markers | Up to ten user-entered event markers to define specific events within the recorded image sequence . |
| Download While Recording | FASTCAM Mini WX supports Partition Recording Mode, allowing image data captured in one memory partition to be downloaded while at the same time recording into another partition. |
| Automatic Download | The system can be set to automatically download image data to the control PC and, when download is complete to re-arm in readiness for the next trigger with automatically incremented file names. |
| Software Binning | Virtual pixel binning (2x2, 4x4 etc.) allows increased light sensitivity with reduced image resolution without changing camera field of view. |

Operation Software Features

| | |
|------------------------------------|---|
| Image Calibration | 2D image calibration allows the measurement of distance and angle from the image. A calibration grid overlay can be superimposed on the image. |
| Image Overlay | A stored reference image may be overlaid on the live image to allow accurate camera positioning to achieve the same view as a previous test. |
| Import of Multiple Image Sequences | Multiple image sequences can be loaded and simultaneously replayed. Timing of image sequences can be adjusted to create a common time reference. Time based synchronization allows images captured at different frame rates to be synchronized. |
| High Dynamic Range Mode | Making use of the full sensor dynamic range, HDR mode allows enhanced detail in both light and dark areas of an image to be displayed simultaneously. |
| Motion Detector | In order to highlight subtle changes in an image, Motion Detector allows a reference image to be subtracted from a recorded sequence. Details including propagation of shock waves and surface changes during impact can be visualized using the feature. |
| Line Profile | A line profile representing grey levels along a line drawn across any region of the image is displayed. In live mode the Line Profile can be used to ensure optimum image focus is achieved. |
| Histogram | A histogram displaying grey levels within a user-defined image area is displayed. In live mode the Histogram can be used to ensure that optimum exposure levels are set for the scene being recorded. |

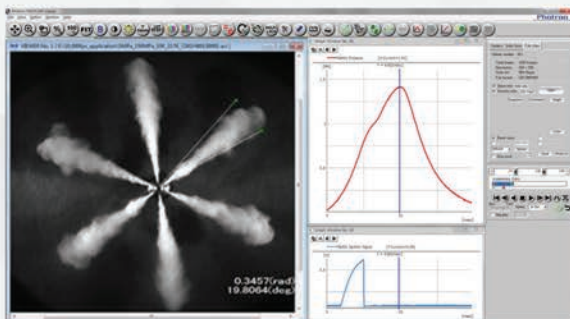

Photron FASTCAM Viewer:

Photron FASTCAM Viewer software (PFV) has been designed to provide an intuitive and feature rich user interface for the control of Photron high-speed cameras, data saving, image replay and simple motion analysis. Advanced operation menus provide access to features for advanced camera operation and image enhancement. Tools are provided to allow image calibration and easy measurement of angles and distances from image data. Also included are a C++ SDK and wrappers for LabView and MATLAB ®.

An optional software plug-in module provides synchronisation between Photron high-speed cameras and data acquired through National Instruments data acquisition systems. Synchronised data captured by the DAQ system provides waveform information which can be viewed alongside high-speed camera images.

Photron FASTCAM Analysis:

PFV software allows image sequences to be exported directly to optional Photron FASTCAM Analysis (PFA) Motion Analysis software. This entry level Motion Analysis software with an on screen 'step by step guide' function launches automatically from Photron FASTCAM Viewer software, and provides automated tracking of up to 5 points using feature or correlation tracking algorithms for the automated analysis of motion within an image sequence.

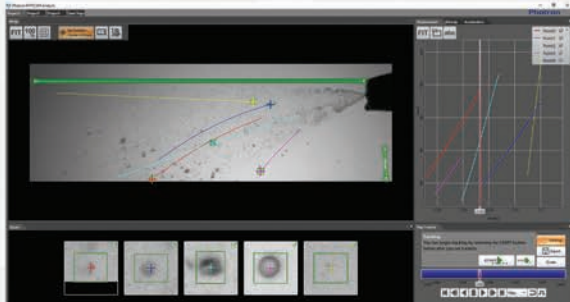

Variable Region of Interest:

Region of Interest (ROI) or sub-windowing allows a user-specified portion of the sensor to be defined to capture images. By using a reduced portion of the image area, the frame rate at which images are recorded can be increased. FASTCAM Mini WX allows the ROI to be set in increments of 256 pixels horizontal and 32 pixels vertical.

Square Image Sensor Format:

Unlike broadcast and media applications where image formats such as 16:9 have now become standard, in scientific and industrial imaging applications an image sensor with a 1:1 image format is generally accepted to be advantageous. To capture the maximum useful image data in applications including microscopy, detonics, combustion imaging and many others, a 1:1 sensor format provides greater flexibility than 'letterbox' image formats. The FASTCAM Mini WX image sensor allows the user to choose either square or rectangular image formats in order to obtain the maximum subject information.

External Frame Synchronization:

The FASTCAM Mini WX camera can be fully synchronized with an external event to allow the timing of when each individual image is captured to be precisely referenced. The camera can be accurately synchronized to unstable frequencies allowing complex events such as combustion in rapidly accelerating or decelerating engines to be recorded and studied.

Record During Download Operation:

FASTCAM Mini WX recording memory can be divided into multiple active sections. The user can record an on-going event in one memory partition while at the same time downloading a previously recorded image sequence in order to improve workflow and optimize camera operation.

| Image Resolution (h x v pixels) | Frame Rate (fps) | |
|------------------------------------|------------------|------------|
| | Mini WX50 | Mini WX100 |
| 2048 x 2048 | 750 | 1,080 |
| 2048 x 1600 | 1,000 | 1,350 |
| 2048 x 1440 | 1,125 | 1,500 |
| 2048 x 1088 | 1,500 | 2,000 |
| 1536 x 1024 | 1,875 | 2,500 |
| 1280 x 1280 | 1,600 | 2,250 |
| 1280 x 800 | 2,700 | 3,600 |
| 1024 x 1024 | 2,250 | 3,200 |
| 1024 x 576 | 4,000 | 5,400 |
| 768 x 768 | 3,600 | 4,800 |
| 768 x 512 | 5,000 | 6,750 |
| 512 x 512 | 6,000 | 8,000 |
| 256 x 256 | 13,500 | 18,000 |
| 256 x 128 | 25,000 | 30,000 |
| 256 x 32 | 67,500 | 80,000 |

Recordable Duration

| Image Resolution (h x v pixels) | Record Duration (frames) | | |
|------------------------------------|--------------------------|-------------|-------------|
| | 8GB Memory | 16GB Memory | 32GB Memory |
| 2048 x 2048 | 1,361 | 2,726 | 5,457 |
| 2048 x 1600 | 1,742 | 3,490 | 6,985 |
| 2048 x 1440 | 1,936 | 3,877 | 7,761 |
| 2048 x 1088 | 2,562 | 5,132 | 10,272 |
| 1536 x 1024 | 3,630 | 7,271 | 14,552 |
| 1280 x 1280 | 3,485 | 6,980 | 13,970 |
| 1280 x 800 | 5,576 | 11,168 | 22,353 |
| 1024 x 1024 | 5,445 | 10,906 | 21,829 |
| 1024 x 576 | 9,680 | 19,389 | 38,807 |
| 768 x 768 | 9,680 | 19,389 | 38,807 |
| 768 x 512 | 14,520 | 29,084 | 58,211 |
| 512 x 512 | 21,781 | 43,626 | 87,317 |
| 256 x 256 | 87,125 | 174,506 | 349,269 |
| 256 x 128 | 174,250 | 349,013 | 698,538 |
| 256 x 32 | 697,002 | 1,396,053 | 2,794,154 |



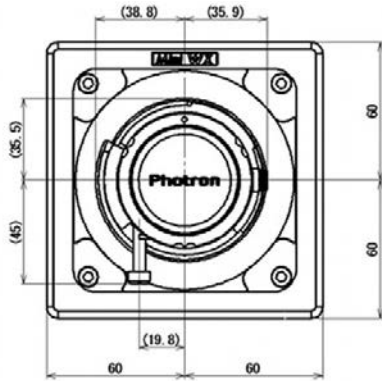

All measurements are in millimeters (mm)

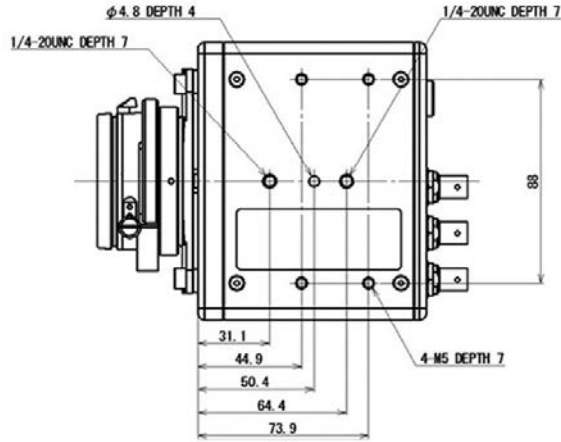
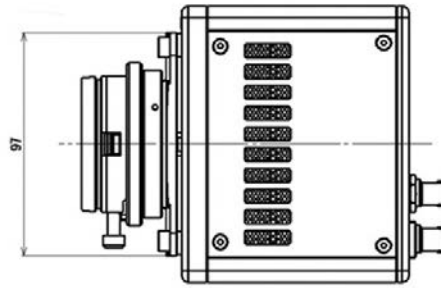

Coupling to other lens systems:

A combination of small physical size, low weight and high light sensitivity allows the FASTCAM Mini WX to be coupled to a range of optical systems such as scientific and long distance microscopes, rigid endoscopes or borescopes and image intensifiers for applications ranging from imaging flows in microfluidic devices to combustion diagnostics.

Rugged Design:

The FASTCAM Mini WX is designed to be used environments where it may be subject to mechanical shock and vibration. The system has been tested to confirm suitability for operation at 100G, 10ms, 6-axes.

Ruggedized Lens Support:

The image sensor size of the FASTCAM Mini WX is compatible with the Schneider Compact range of Ruggedized lenses. Providing a 24mm image circle these lenses are fully compatible with the Mini WX sensor at full HD image resolution. Focal lengths currently available include 20mm, 24mm and 35mm with an aperture of f/2.0.

Specifications subject to change without notice.

Mechanical and Environmental Specifications

Mechanical

| | |
|------------------|---|
| Lens Mount | F-mount (G-type lens compatible) and C-mount provided - Optional lens mounts available include M42 adapter |
| Camera Mountings | 2 x 1/4 - 20 UNC (base and top), 4 x M5 (base) |

External Dimensions

| | |
|--|---|
| Camera Body (excluding protrusions) | 120mm (H) x 120mm (W) x 99mm (D) 4.72" (H) x 4.72" (W) x 3.90" (D) |
|--|---|

Weight

| | |
|-------------|-----------------|
| Camera Body | 1.6kg (3.52lbs) |
|-------------|-----------------|

Environmental

| | |
|-----------------------|---|
| Operating Temperature | 0 to 40C, 32° to 104°F |
| Storage Temperature | -20 to 60C, -4° to 140°F |
| Humidity | 85% or less (non condensing) |
| Cooling | Internal fan cooling (fan-off mode supported) |
| Operational Shock | 100G, 10ms, 6-axes |

Power

| | |
|----------------------------------|-------------------------|
| AC Power (with supplied adapter) | 100 to 240V, 50 to 60Hz |
| DC Power | 22 to 32V, 55VA |

PHOTRON USA, INC.
9520 Padgett Street, Suite 110
San Diego, CA 92126
USA

Tel: 858.684.3555 or 800.585.2129
Fax: 858.684.3558
Email: image@photron.com
www.photron.com

PHOTRON EUROPE LIMITED
The Barn, Bottom Road
West Wycombe, Bucks. HP14 4BS
United Kingdom

Tel: +44 (0) 1494 481011
Fax: +44 (0) 1494 487011
Email: image@photron.com
www.photron.com

PHOTRON (Shanghai)
Room 20C, Zhao-Feng
World Trade Building
No. 369, JiangSu Road
ChangNing District
Shanghai, 200050 China
Tel: +86 (0) 21-5268-3700
Email: info@photron.cn.com
www.photron.cn.com

PHOTRON LIMITED
Kanda Jinbo-cho 1-105
Chiyoda-ku, Tokyo 101-0051
Japan

Tel: +81 (0) 3 3518-6271
Fax: +81 (0) 3 3518-6279
Email: image@photron.co.jp
www.photron.co.jp